

BUIS NATUREL  
TUYAU NATUREL  
PIPE NATURAL

L = 5 m

da	s	KG/ST/PC	€/M
32	2.3	0.51	150.68
50	2.3	0.82	242.27
63	2.3	1.04	308.45
90	2.3	1.51	446.13
110	2.3	1.85	547.76

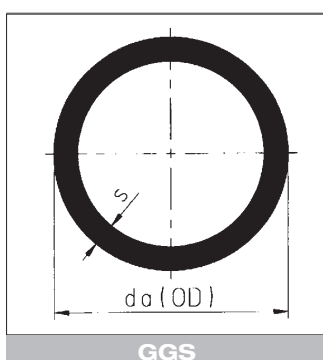

BUIS GGS GLASDOEK GELAMINEERD  
TUYAU GGS LAMINE FIBRES DE VERRE  
PIPE GGS GLASS BACKING

L = 5 m

da	s	KG/ST/PC	€/M
32	2.3	0.61	461.80
50	2.3	0.98	532.39
63	2.3	1.25	679.07
90	2.3	1.80	859.17
110	2.3	2.21	1021.82

L = 1 m

da	s	KG/ST/PC	€/M
32	2.3	0.61	531.07
50	2.3	0.98	612.25
63	2.3	1.25	780.92
90	2.3	1.80	988.05
110	2.3	2.21	1175.09

Drukloos toepasbaar van -190°C tot +260°C  
Applications sans pression de -190°C à +260°C  
Pressureless applications from -190°C to +260°C