

BUIS NATUREL
TUYAU NATUREL
PIPE NATUREL

L = 5 m

da	s	KG/ST/PC	€/M
32	2.3	0.51	215.70
50	2.3	0.82	346.81
63	2.3	1.05	444.07
90	2.3	1.51	638.60
110	2.3	1.86	786.64
160	2.3	2.72	1150.37

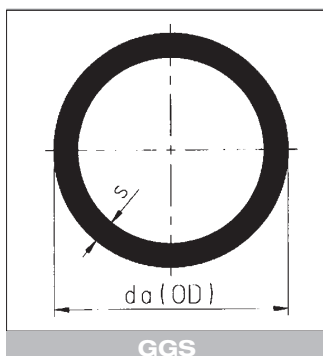

BUIS GGS GLASDOEK GELAMINEERD
TUYAU GGS LAMINE FIBRES DE VERRE
PIPE GGS GLASS BACKING

L = 5 m

da	s	KG/ST/PC	€/M
32	2.3	0.61	734.48
50	2.3	0.98	846.76
63	2.3	1.25	1080.06
90	2.3	1.80	1366.54
110	2.3	2.21	1602.67
160	2.3	3.23	2303.20

GGS

L = 1 m

da	s	KG/ST/PC	€/M
32	2.3	0.61	886.92
50	2.3	0.98	1022.49
63	2.3	1.25	1304.21
90	2.3	1.80	1650.08
110	2.3	2.21	1935.20
160	2.3	3.23	2781.12

Drukloos toepasbaar van -190°C tot +205°C
Applications sans pression de -190°C à +205°C
Pressureless applications from -190°C to +205°C