

BUIS NATUREL
TUYAU NATUREL
PIPE NATURAL

L = 5 m

da	s	KG/ST/PC	€/M
32	2.3	0.51	239.68
50	2.3	0.82	396.89
63	2.3	1.04	490.59
90	2.3	1.51	709.60
110	2.3	1.85	871.21

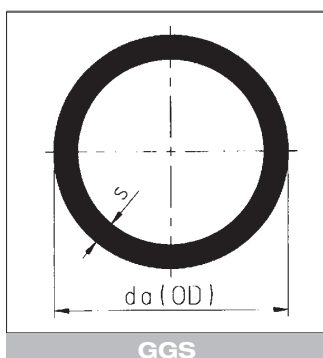

BUIS GGS GLASDOEK GELAMINEERD
TUYAU GGS LAMINE FIBRES DE VERRE
PIPE GGS GLASS BACKING

L = 5 m

da	s	KG/ST/PC	€/M
32	2.3	0.61	771.22
50	2.3	0.98	889.09
63	2.3	1.25	1134.06
90	2.3	1.80	1434.88
110	2.3	2.21	1706.50

L = 1 m

da	s	KG/ST/PC	€/M
32	2.3	0.61	929.18
50	2.3	0.98	1071.18
63	2.3	1.25	1366.33
90	2.3	1.80	1728.68
110	2.3	2.21	2055.90

Drukloos toepasbaar van -190°C tot +260°C
Applications sans pression de -190°C à +260°C
Pressureless applications from -190°C to +260°C